

INSTALLATION INSTRUCTIONS

Item# 4374-579 (Rev. 02/05/2015)

READ AND SAVE THESE INSTRUCTIONS

WARNING! SHUT POWER OFF AT FUSE OR CIRCUIT BREAKER.

AVERTISSEMENT! COUPER LE COURANT AU NIVEAU DES FUSIBLES OU DU DISJONCTEUR.

PREPARING FOR INSTALLATION (Fig. 3)

1. Shut off the power at the fuse box or circuit breaker. If necessary, remove the old fixture including the mounting hardware.
2. Carefully remove the new fixture from the carton and check that all parts are included as shown in the illustration.
3. Thread the fixture loop (A) onto nipple (B) on the fixture body (E).
4. Thread the bottom finial (G) onto the Nipple (F) until snug.

MOUNTING THE FIXTURE (Fig. 1)

5. Thread the nipple into the ceiling loop until snug.
6. Thread the other end of the nipple into the crossbar until snug. Note: The length of the nipple into the crossbar may be adjusted if necessary.
7. Place the lock washer and hex nut over the end of nipple protruding through crossbar. Then thread the hex nut onto the nipple until snug.
8. Take this crossbar assembly and mount it to ceiling outlet box using the mounting screws (Size: #8-32N*L0.5"). The side of crossbar marked "GND" must face out.
9. Use proper chain pliers to open one end link of the chain and connect to the fixture loop. Then close the link.
10. By measuring, determine the correct number of links needed for the desired hanging height. Using the chain pliers, disconnect and discard the excess chain.
11. Carefully lace the fixture wires through the chain.
12. Slip the lock collar and canopy over the chain and allow them to rest on the fixture body.
13. Open the other end of the chain and attach it to the ceiling loop. Then close the chain.
14. Carefully feed the fixture wires through the ceiling loop and nipple and pull tight.

CONNECTING THE WIRES (Fig. 2)

15. At this point, connect the electrical wires as shown in Fig. 2 making sure that all wire connectors are secured. If your outlet box has a ground wire (green or bare copper), connect the fixture's ground wire to it. Otherwise, connect the fixture's ground wire directly to the crossbar using the green screw provided.
16. Tuck the wire connections neatly into the ceiling outlet box and raise the canopy to the ceiling. Thread the lock collar to the ceiling loop to secure the canopy against the ceiling.

FINISHING THE INSTALLATION (Fig. 3)

17. Place the tube (C) over the socket of the fixture body (E)
18. Install light bulbs (H) in accordance with the fixture's specification. **(DO NOT EXCEED THE MAXIMUM WATTAGE RATING) (NE PAS DEPASSER LA PUISSANCE NOMINALE MAXIMALE!).**

Your installation is now complete. Return power to the outlet box and test the fixture.

Note: Illustration (Fig. 3) on this manual is for installation purposes only. It may or may not be identical to the fixture purchased.

Fig. 1

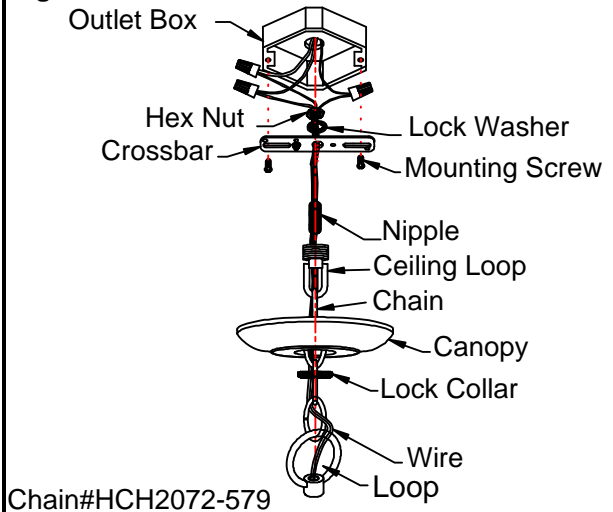

Chain#HCH2072-579

Fig. 2

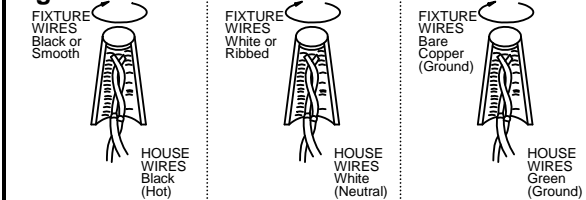
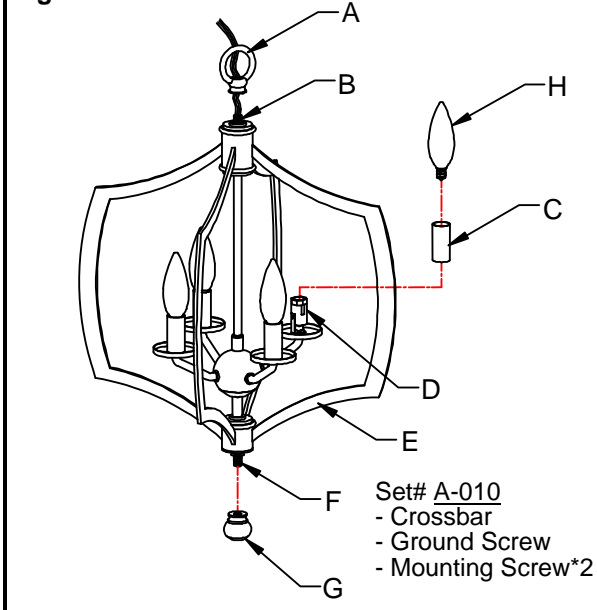

Fig. 3



Notice: It is important to use proper chain pliers (not included) To OPEN and CLOSE the chain included with this fixture. Do not open them with other tools that may twist or stress the chain links. It is important to use proper chain pliers like the ones shown in the diagram.



LA-2468E